

Masszeichnung

Frischwaretheke ENIXE EI200 2500 M2

[Art. 489200131]

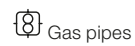
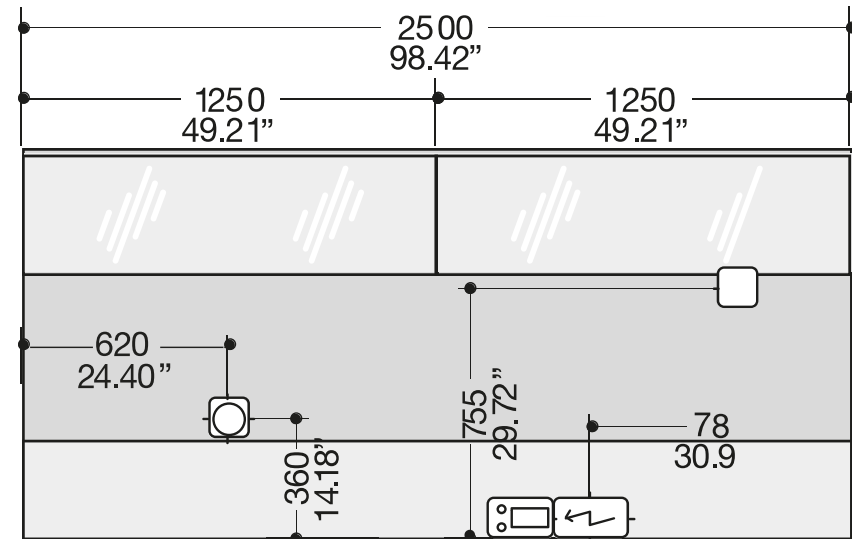
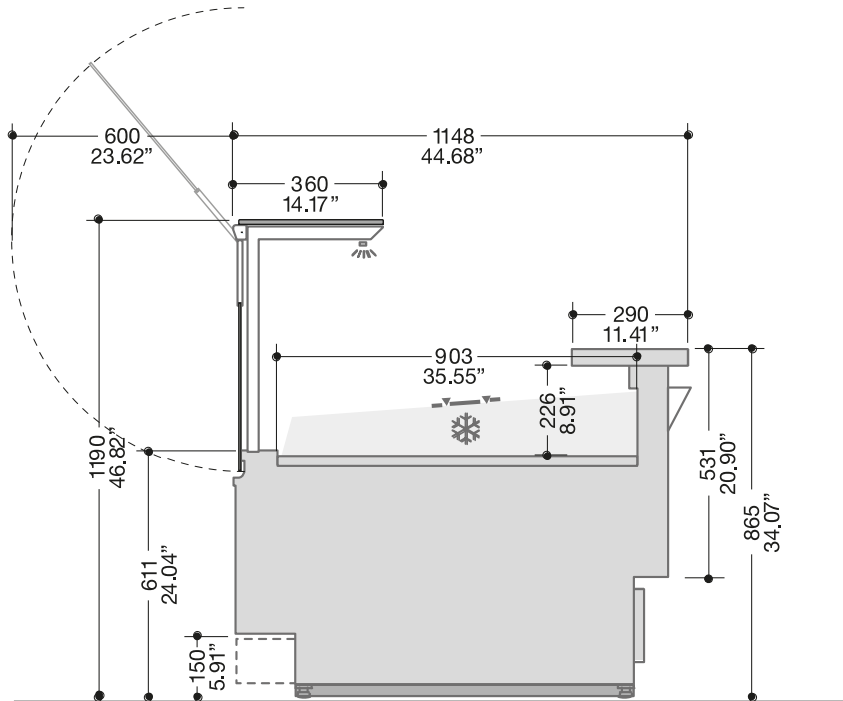

Gas pipes



Water drain



Control panel



Electric panel