

# Masszeichnung

## Frischwaretheke ENIXE EI200 3750 M2

[Art. 489200151]

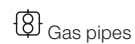
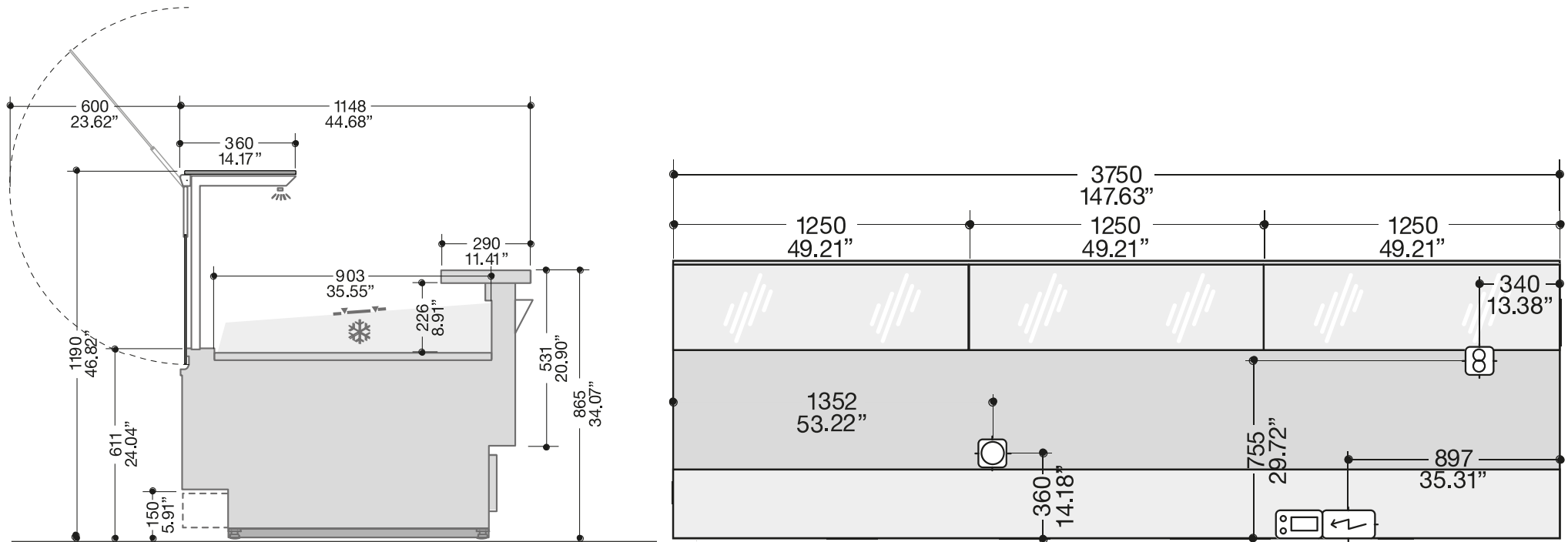

Gas pipes



Water drain



Control panel



Electric panel