

# Masszeichnung

## COOL-LINE Vitrine KRISTALL 150 UM

[Art. 506050150]

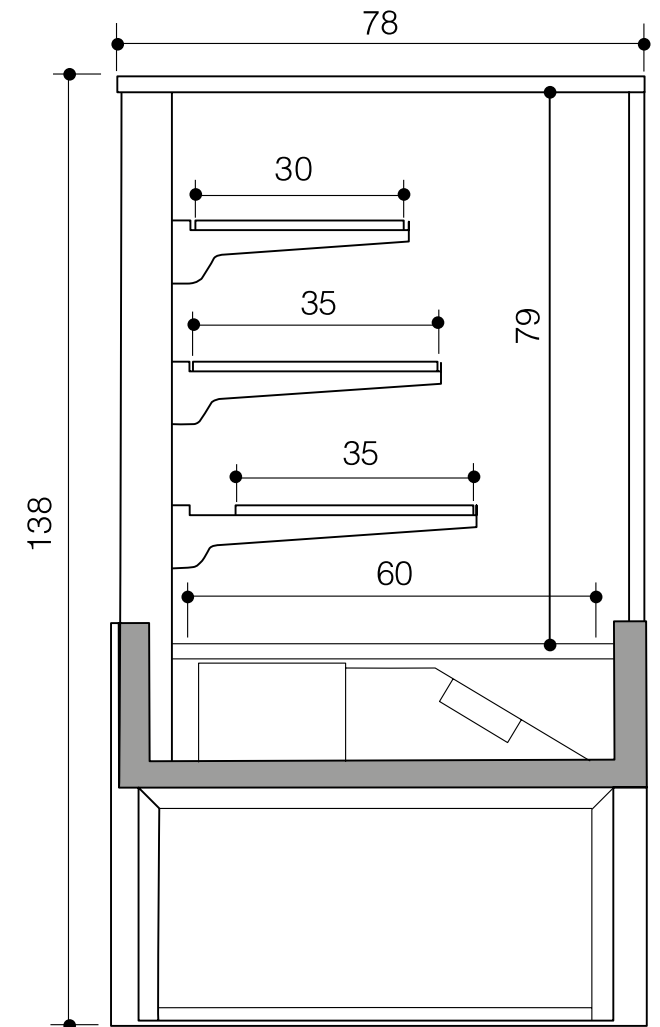
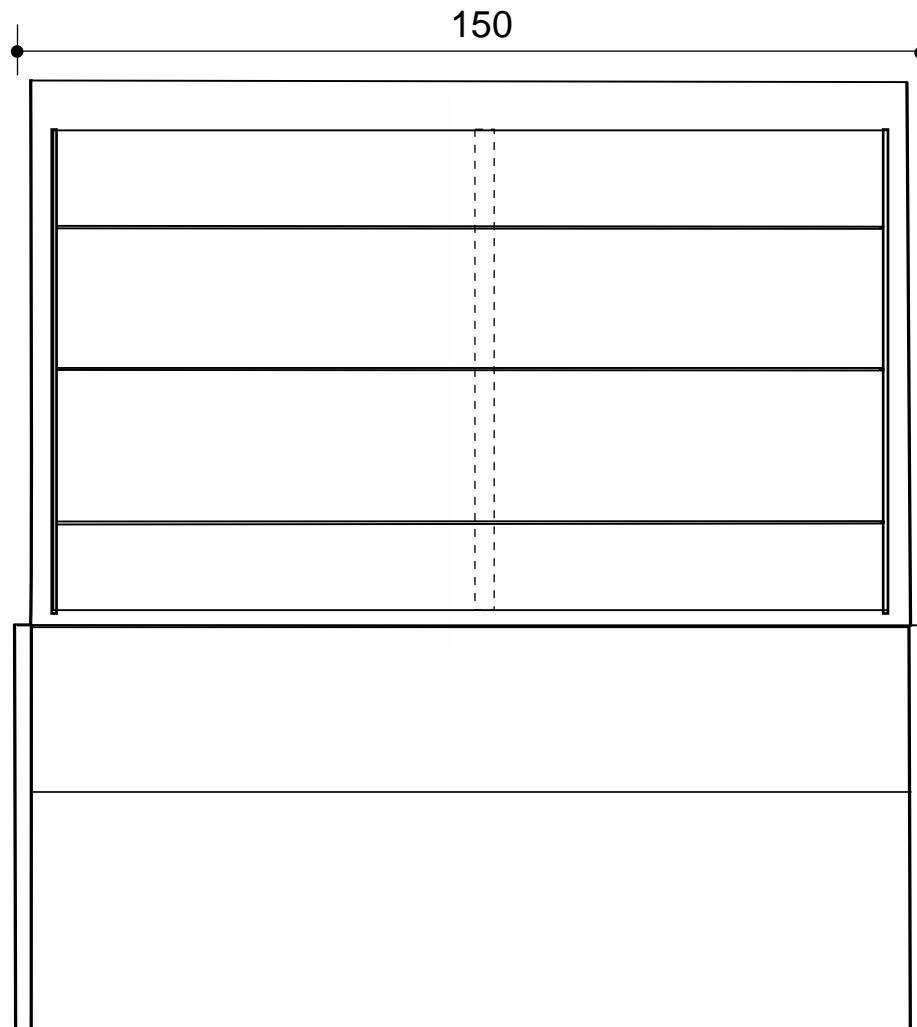

\* Alle Angaben in cm